

15 cm

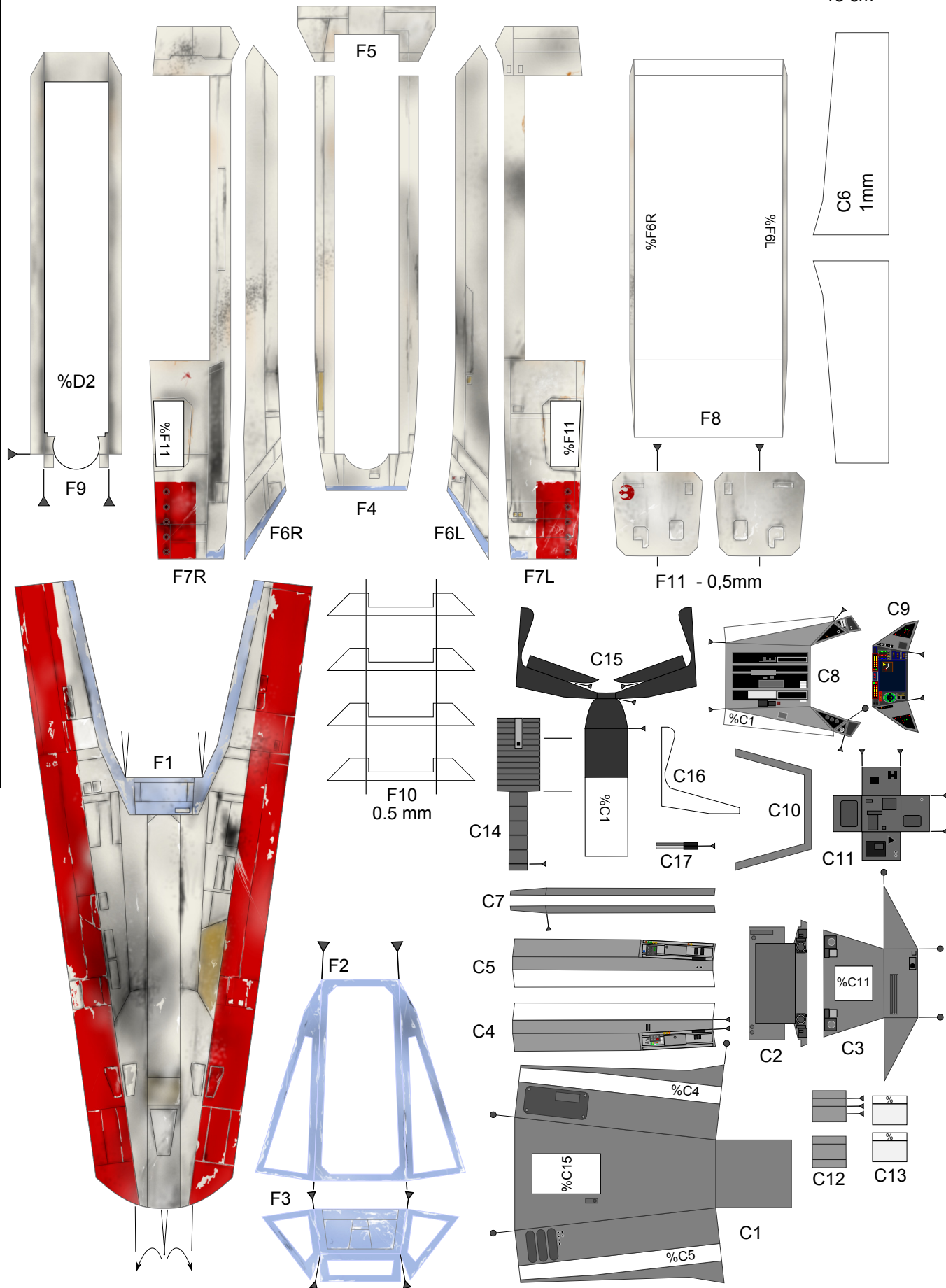

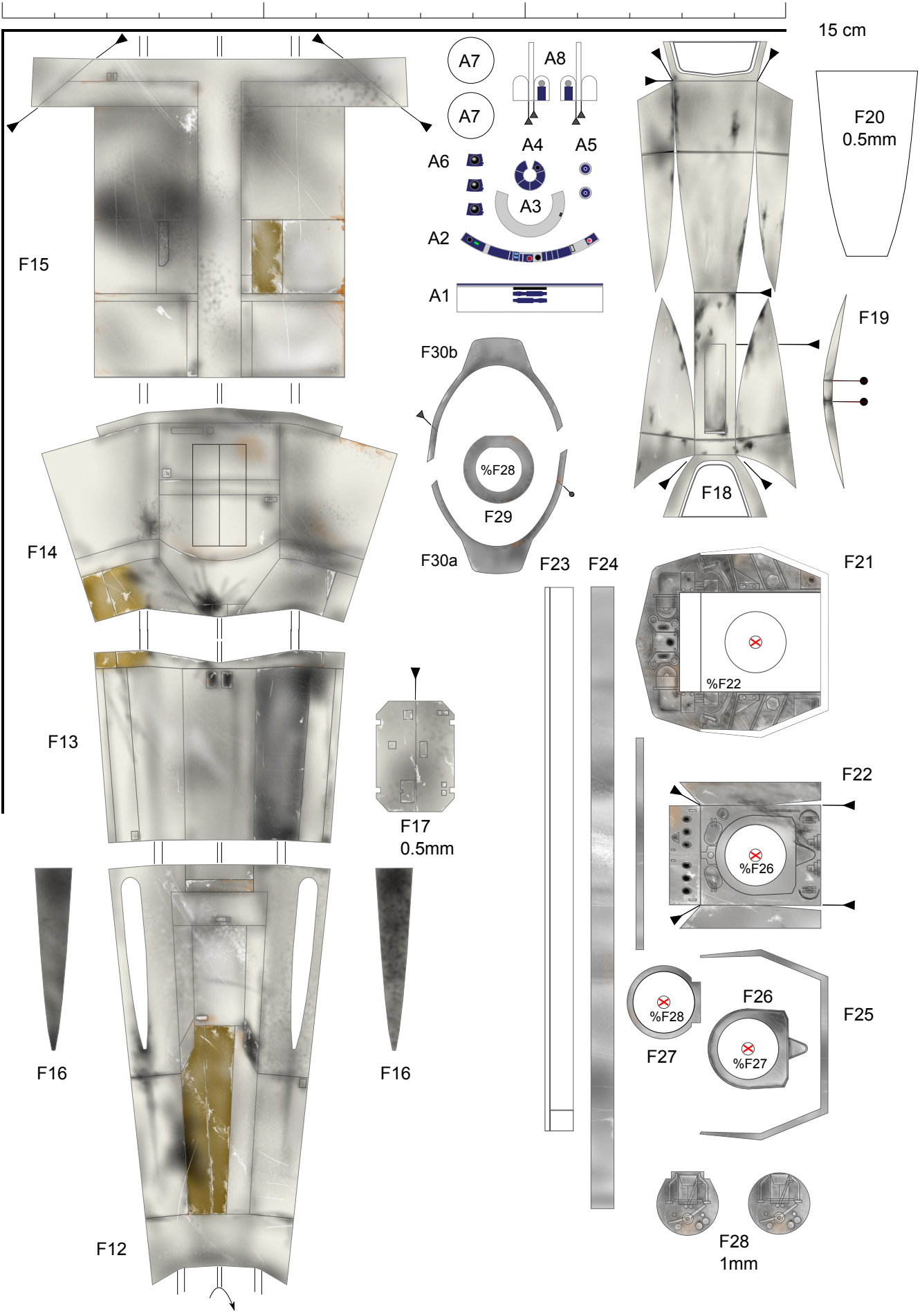

15 cm

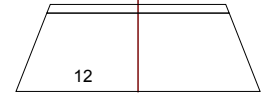
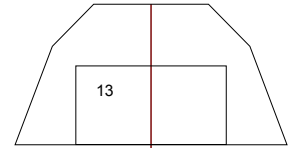
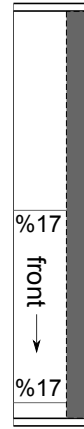
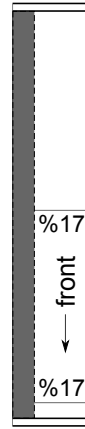
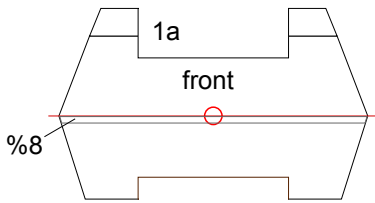
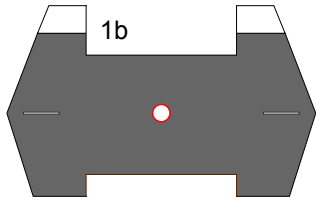
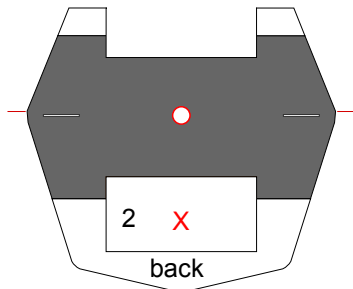

Recommended paper thickness:
1mm: parts 1b, 2, 3, 4, 5
0,5 or 1mm: part 8a
0,5mm: parts 9, 11-17

8a,b - cut according to the thickness of part 1

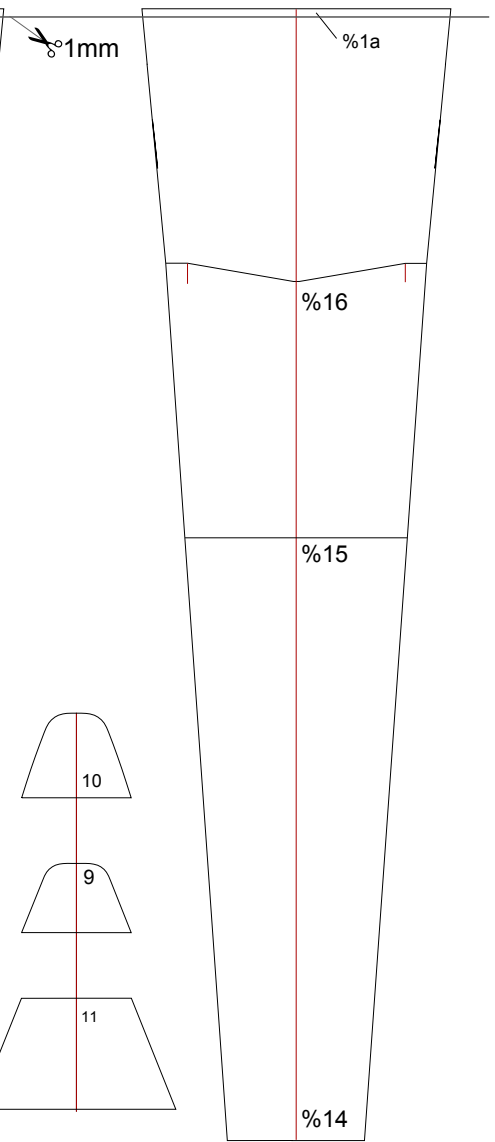
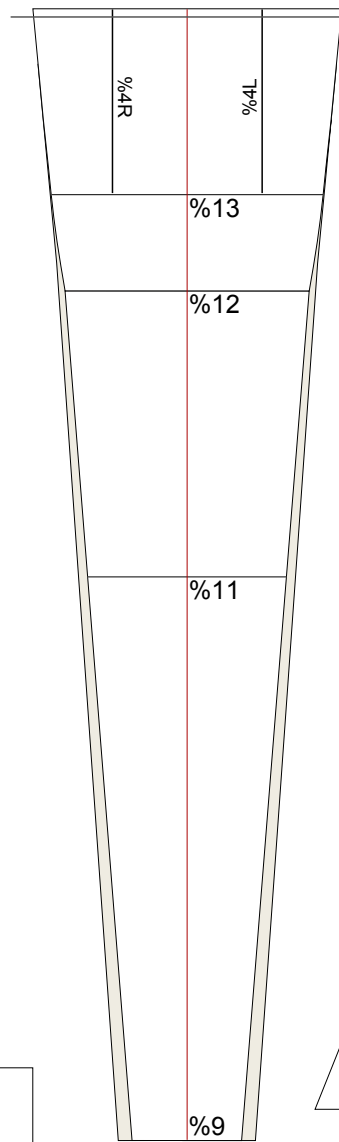
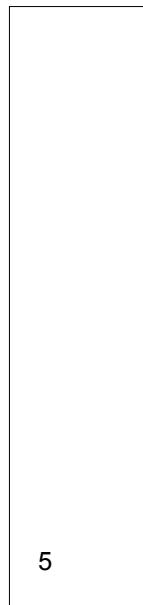

1 mm ? 0.5 mm

cut according to the thickness of part 8



profile

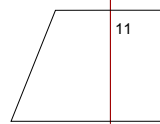
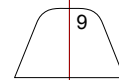
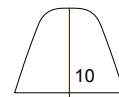
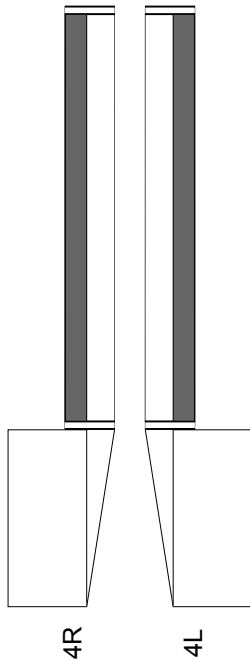

cut according to the thickness of part 7

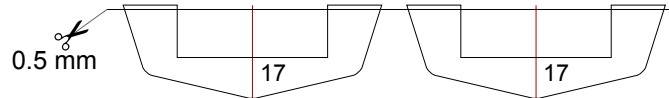

15 cm

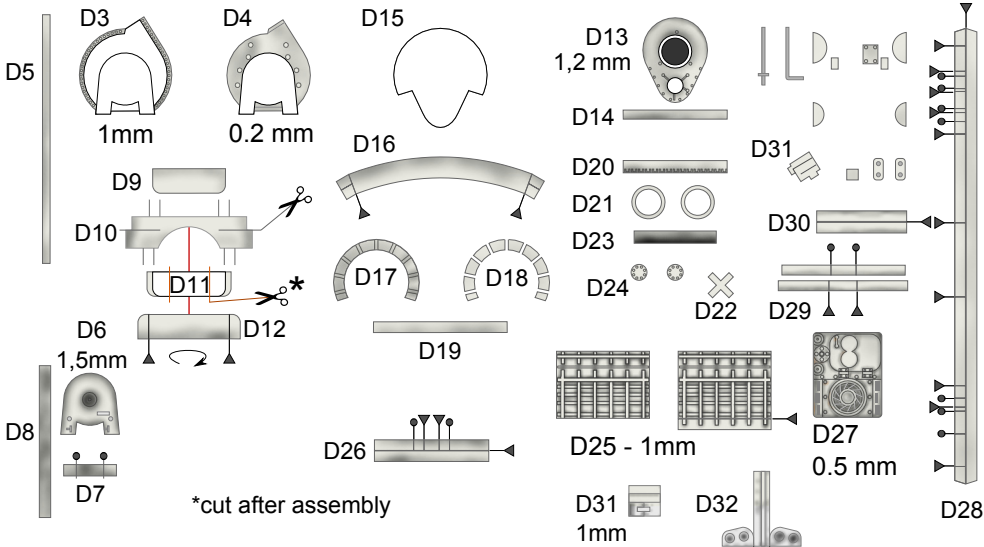

D2
0.5 mm

X-Wing paper model by David Pethes, 2011.
Original miniature design by Industrial
Light & Magic (Joe Johnston, Colin Cantwell)

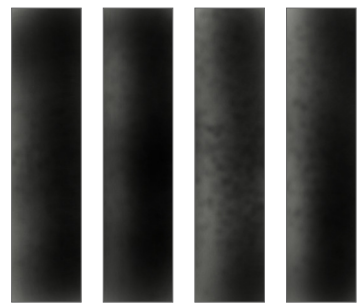
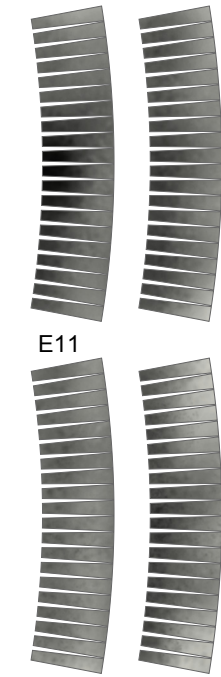
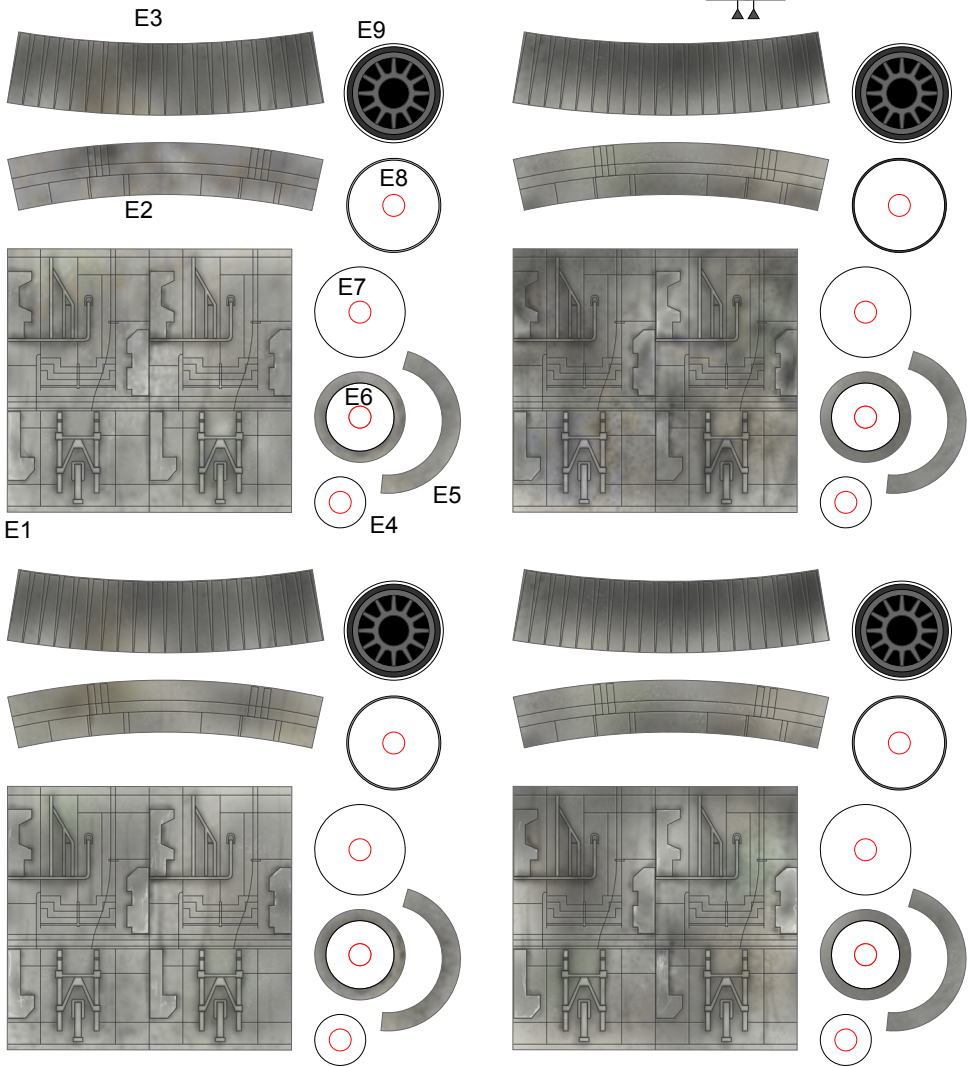

E10

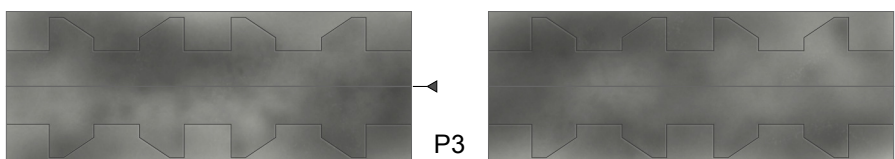

P3

Model is freely available at
<http://imcold.evilhosting.org/web/xwing/>
 Not for sale or another commercial usage.
 Do not redistribute or modify. Thanks!
 Release date: 9.9.2011

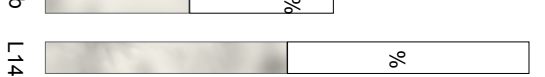
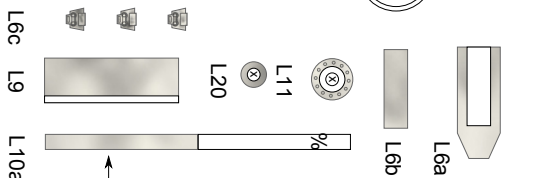
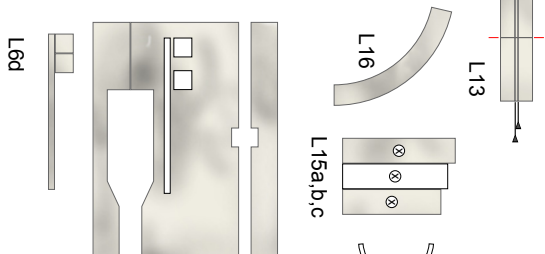
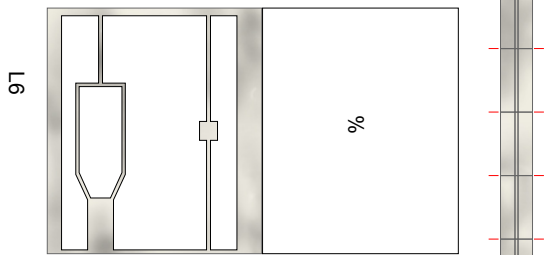
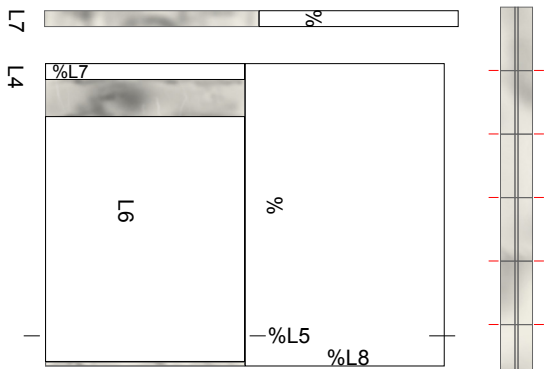
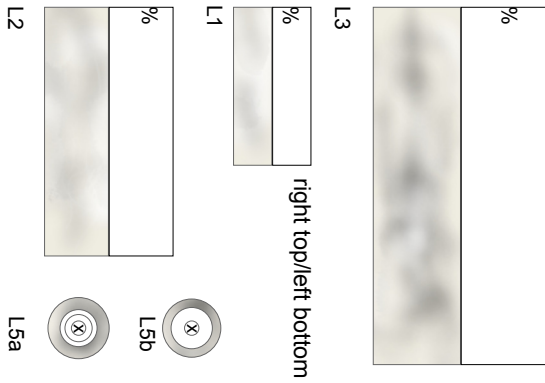
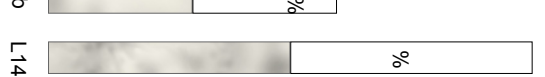
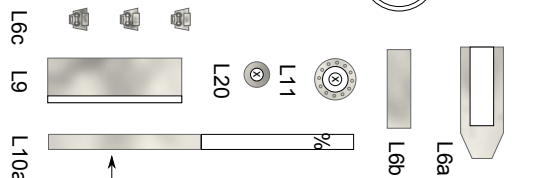
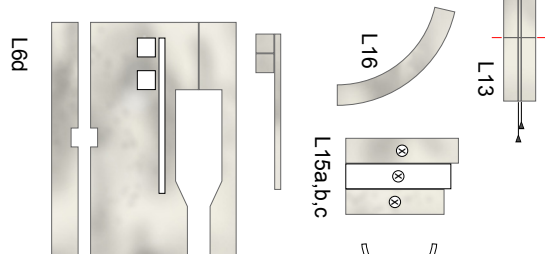
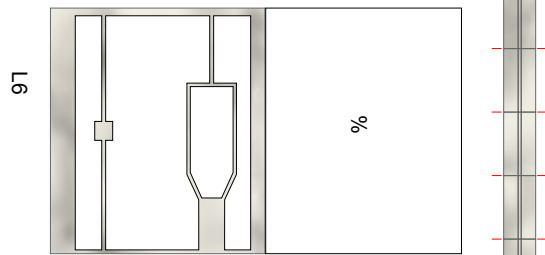
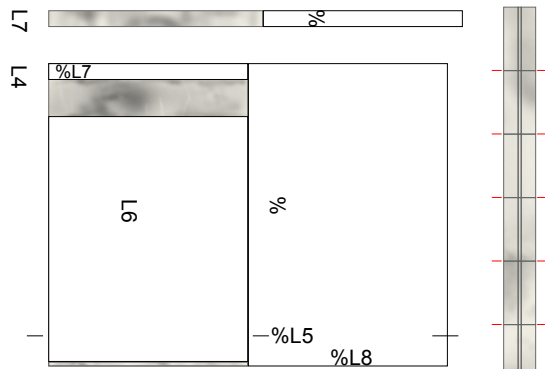
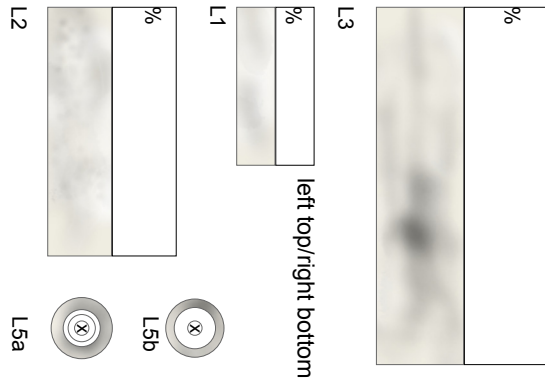

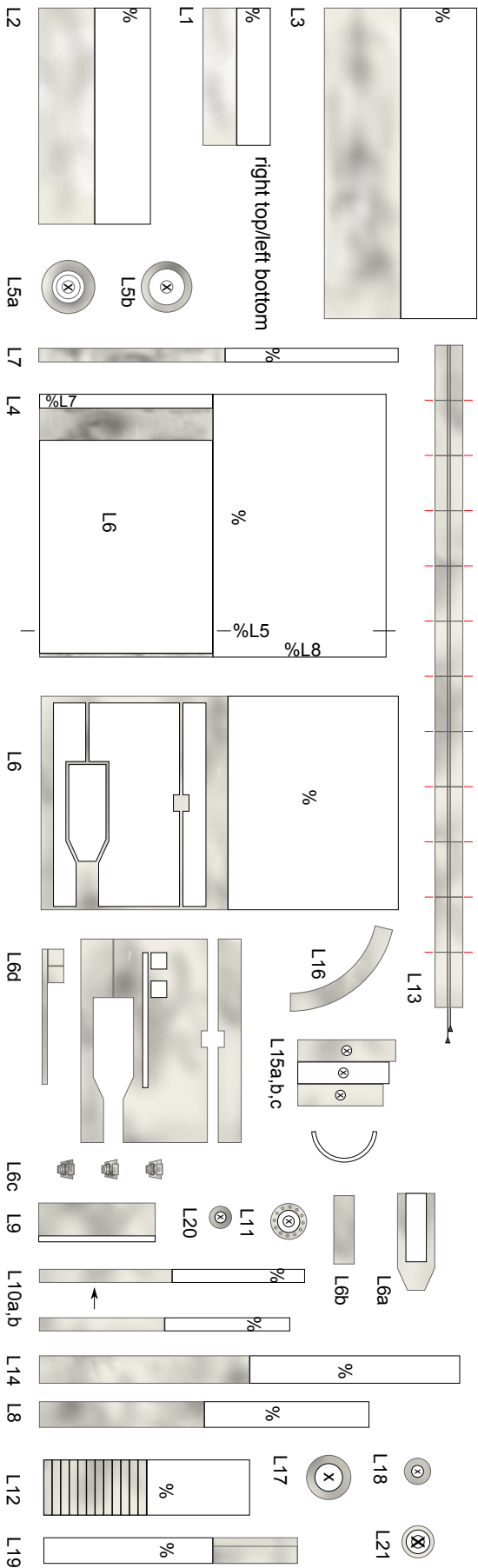
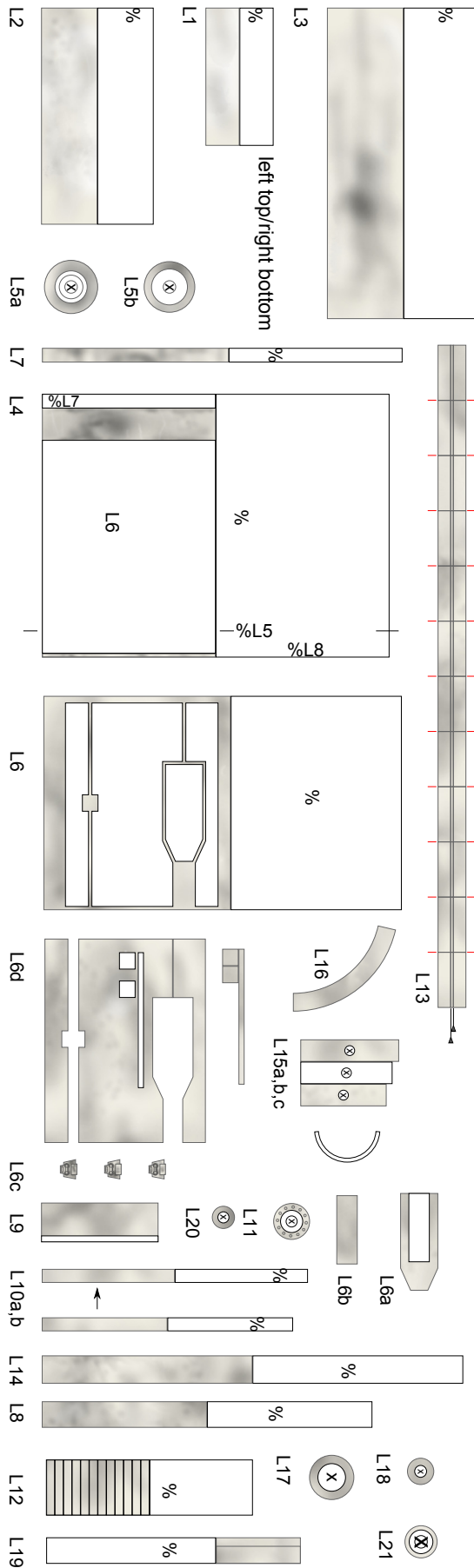

right top /
left bottom

15 cm

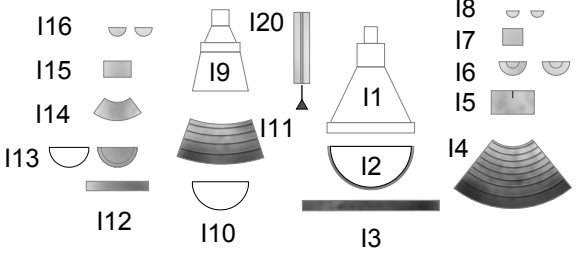
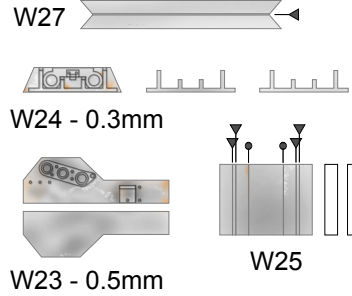

W26

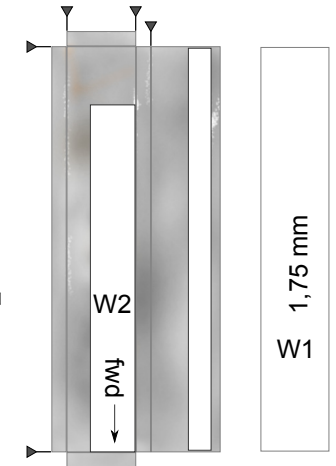
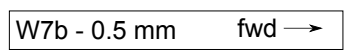
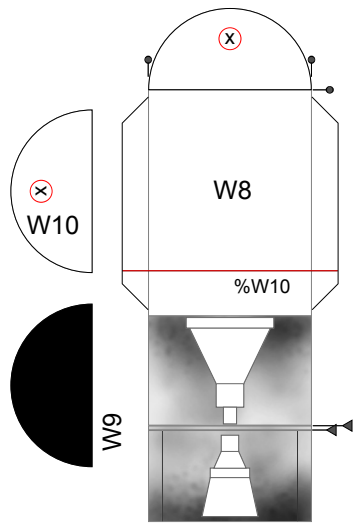
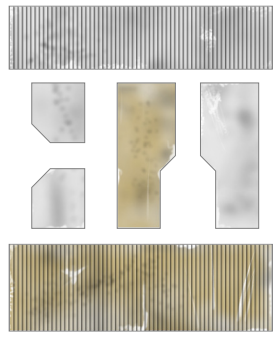
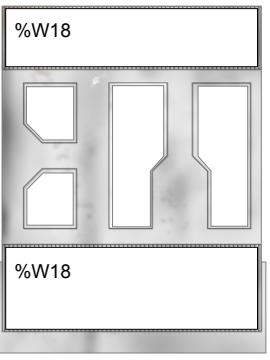
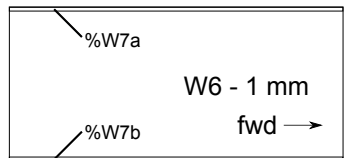
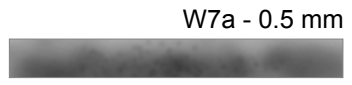
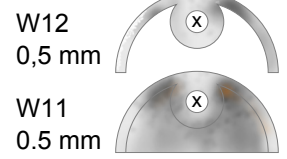

W13



W19

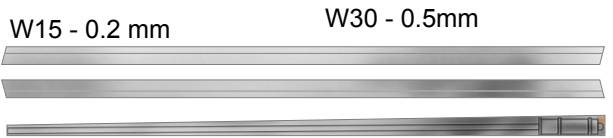
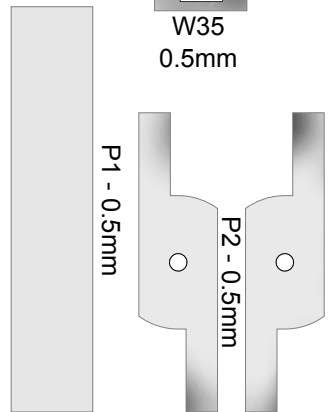
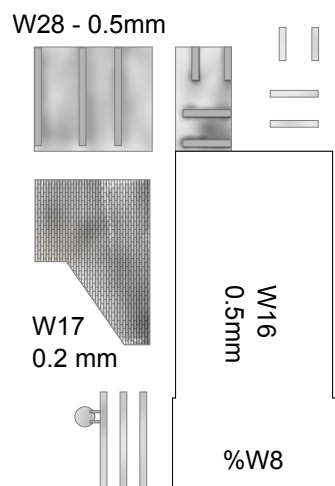
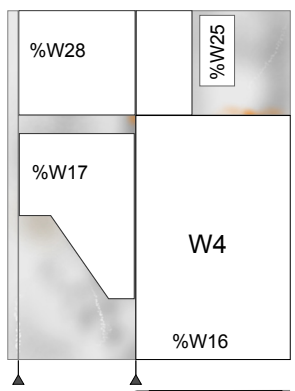
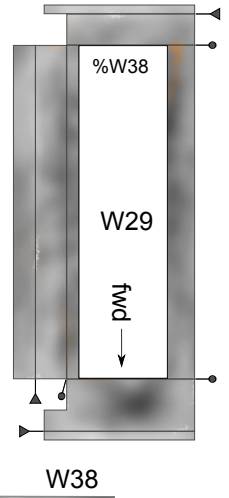
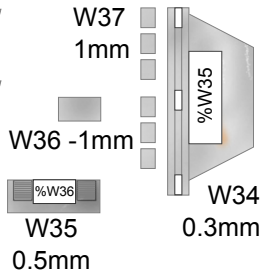
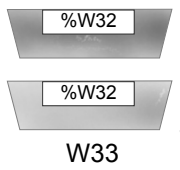
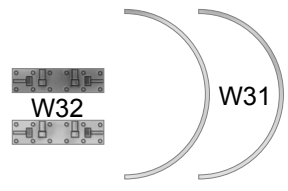

15 cm

right top /
left bottom

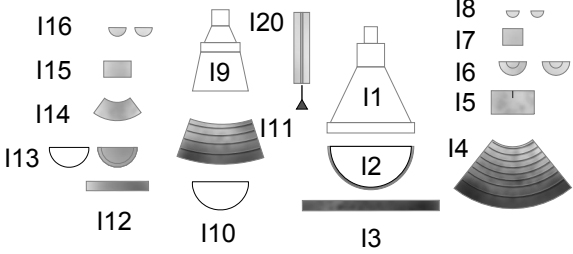
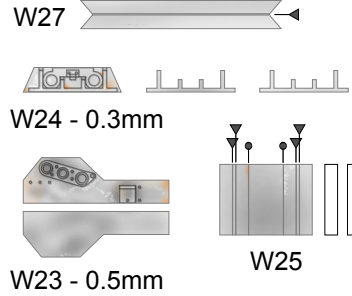

W26

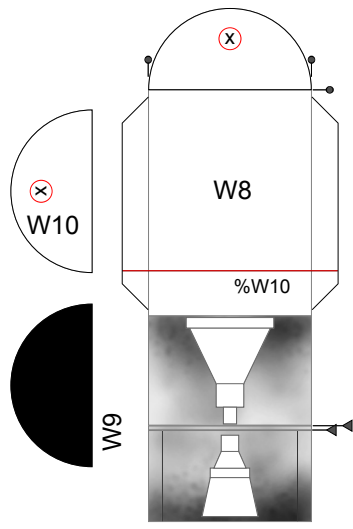
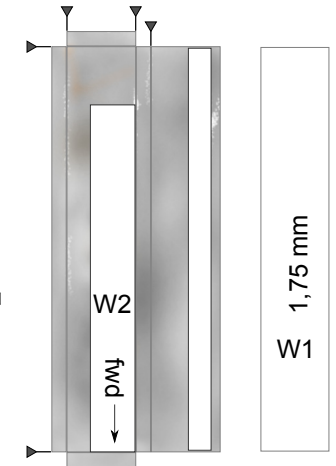
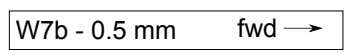
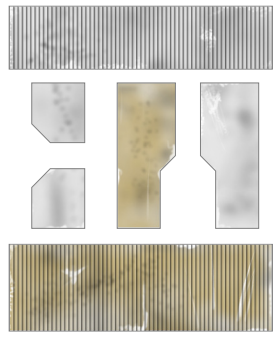
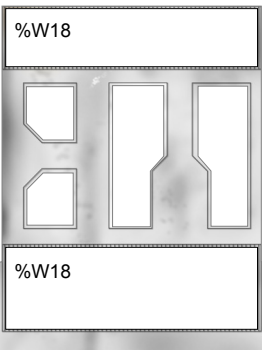
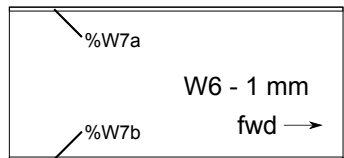
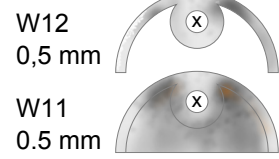

W13

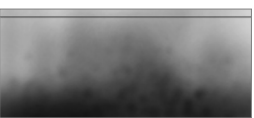

W19

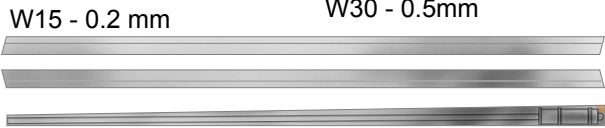
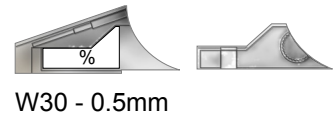
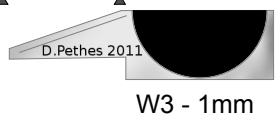
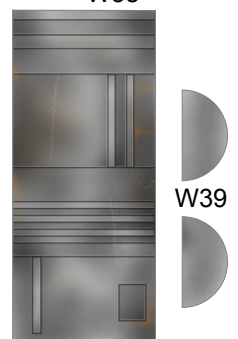
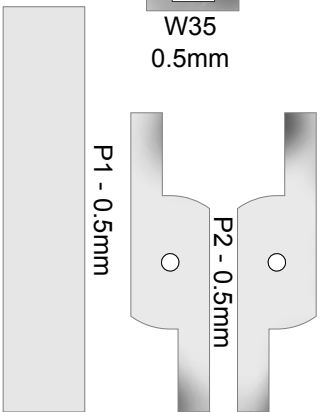
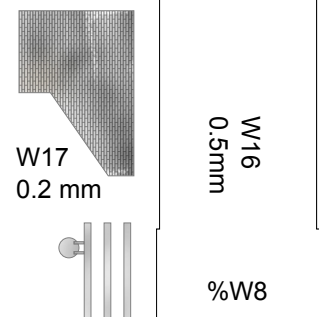
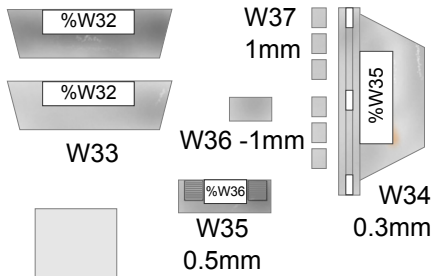
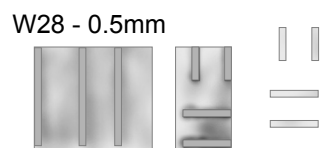
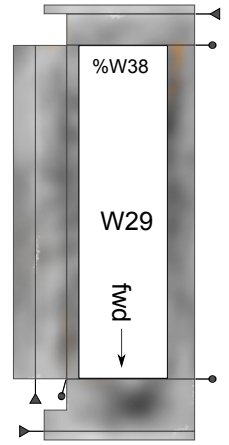
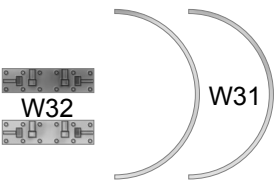

15 cm

left top / right bottom

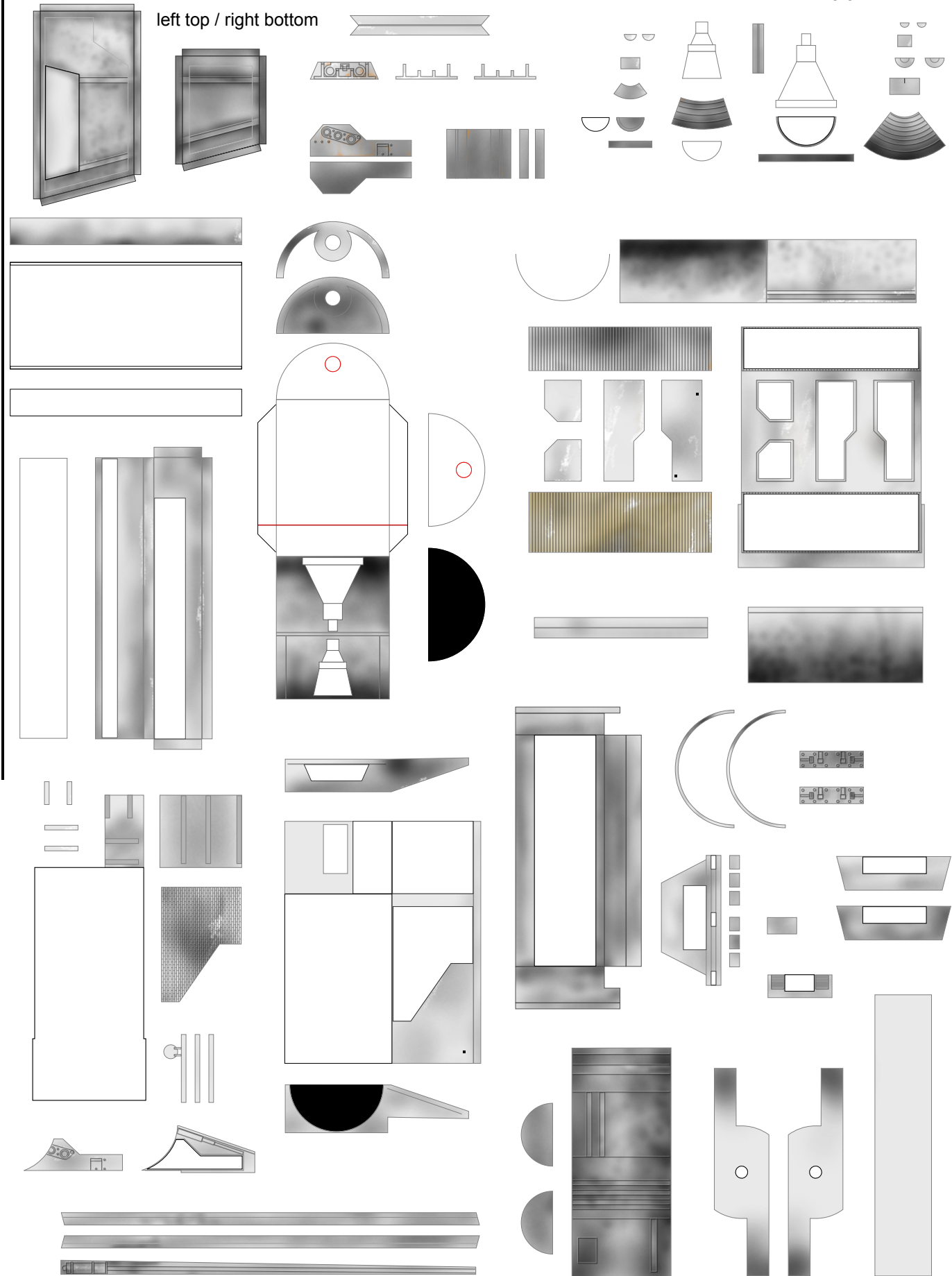

15 cm

left top / right bottom

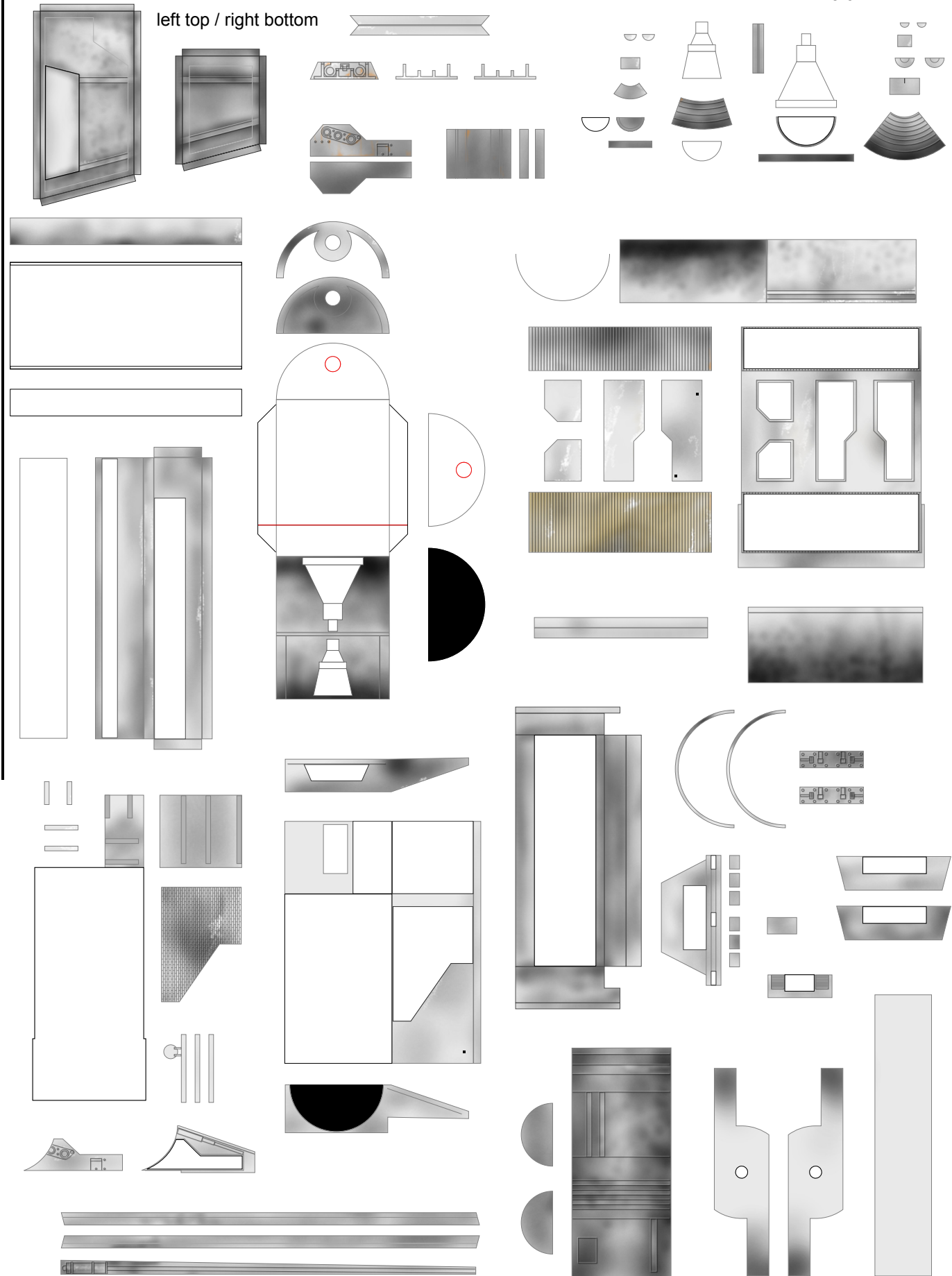

15 cm

W14

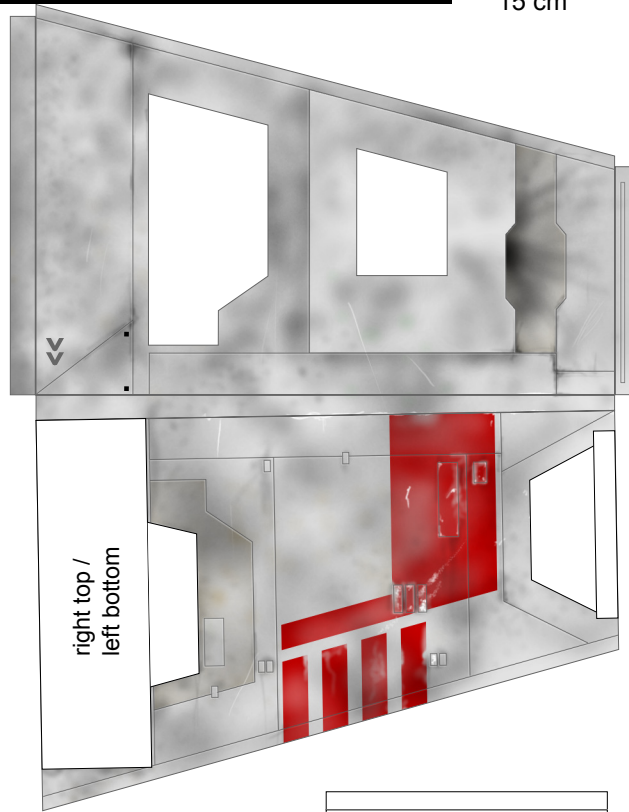
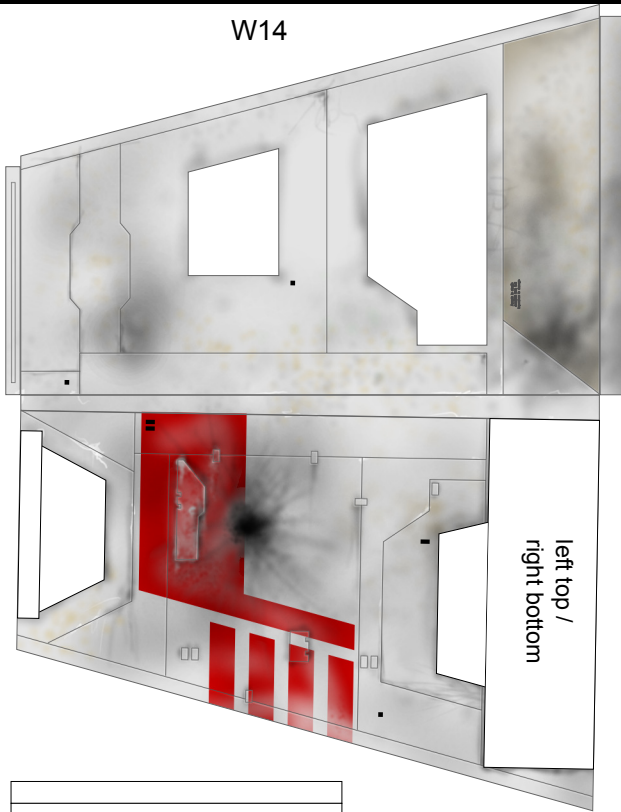

left top /
right bottom

right top /
left bottom

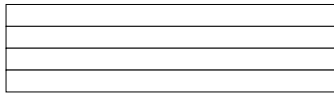

WF3

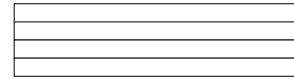

WF4

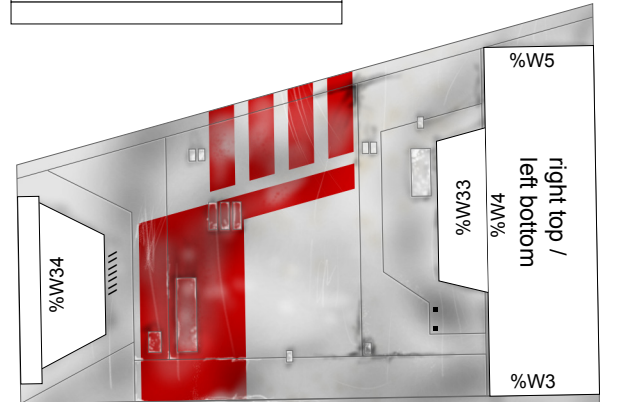

right top /
left bottom

left top /
right bottom

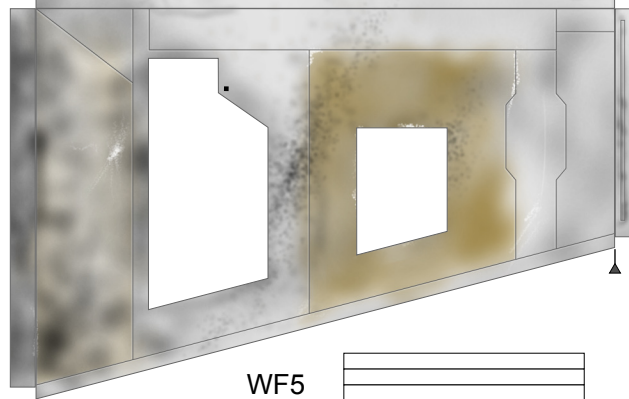
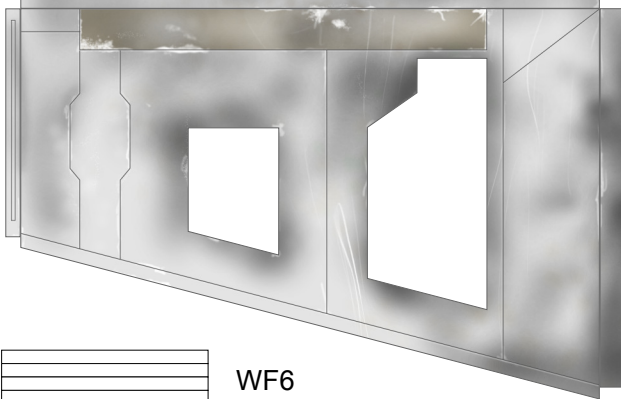

WF6



WF5

WF1

WF2

